

Maintenance instructions

High-tech flooring, beautifully maintained



2tec2[®]
high tech flooring



With 2TEC2's woven vinyl flooring, maintaining your floor will be simple and fast. Our floors are stain-resistant, making it easy to expunge even the most stubborn blemishes. With just water and basic cleaning supplies, your floors will look as though they were just installed, even years after.

2TEC2 is a 100% Belgian company devoted to designing and producing recyclable high-tech woven flooring. Focused on weaving aesthetic tiles and rolls for the project market, the company aims for a superior performance in quality, functionality and durability.

1.	Introduction	4
2.	Prevention & protection	5
2.1	Make the right choices	5
2.2	Entrance matting	5
3.	Maintenance	6
3.1	After installation	6
3.2	Daily maintenance	6
3.3	Periodic maintenance	7
4.	Spot cleaning	8
4.1	General spot cleaning	8
4.2	Stubborn stains	8
4.2.1	Stains caused during renovations	8
4.2.2	Food and beverages	9
4.2.3	Other common stains	9
5.	Maintenance in healthcare	10
5.1	Expected standards	10
5.2	Disinfecting 2TEC2	10
5.3	Types of areas	11
5.4	Chemical resistance & recommended products	12
6.	Machine recommendations	13
6.1	Daily maintenance	13
6.2	Deep clean - large surfaces	14
6.3	Deep clean - small surfaces	16
7.	Professional cleaning contacts	17
8.	Do's & don'ts	18
9.	Case study	18
10.	Frequently asked questions	19

1. Introduction

Clean floors give your occupants peace-of-mind. 2TEC2's woven top layer is made from PVC yarns with a glass fibre core, making it perfectly cleanable with water and detergents.

Our mass-dyed yarns are exceptionally colour-fast, so cleaning will not cause any fading.

Most stains are easily and quickly removed, in contrast with other types of textile floor coverings. However, sand and dirt have an abrasive effect on 2TEC2. In the long run, this will result in a change of appearance.

A good maintenance guarantees:

- » an increased life expectancy
- » a perfect hygiene
- » a better aesthetic
- » a far better appearance retention in time



2. Prevention & protection

2.1 Make the right choices

Areas with high foot traffic tend to accumulate more dirt and stains. Lighter colours are more likely to show these dirt particles. That is why it is important to choose the right shade for different types of areas.

We can assist you in selecting the right colour and design from our wide range, by taking into account the density of the foot traffic per area. Concealing dirt helps making your floor look pristine all of the time.

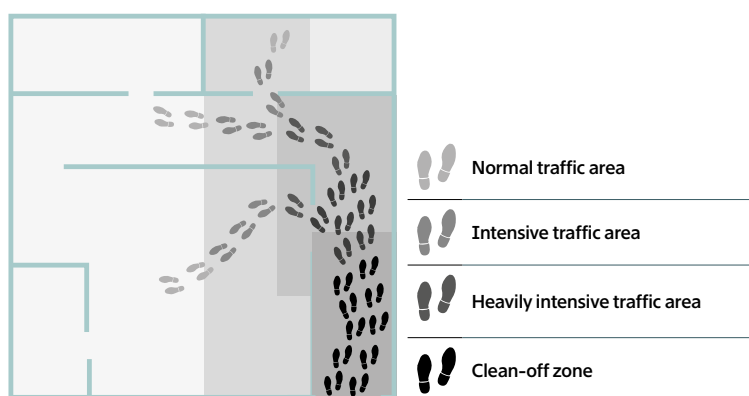

2.2 Entrance matting

To preserve the appearance of 2TEC2 flooring, it is essential to limit the intrusion of soil and dirt from outside elements. This can be done with a 'clean-off zone' where entrance matting intercepts and traps dirt particles effectively. An entrance mat can catch up to 90% of incoming dirt.

3 zones should be taken into consideration:

- » Outdoor matting to collect wet dirt and moisture
- » Brush zones to clean footwear
- » Washable dust mats inside



We recommend the use of an entrance mat both outside and inside at entrances.



3. Maintenance

2TEC2 is a non-permeable flooring with a woven 3-dimensional structure. This means 2TEC2 can be cleaned with any amount of water, as long as that water is extracted afterwards. In case of tile installations, a waterproof subfloor is recommended as water may reach the subfloor through the seams.

3.1 After installation

After installing 2TEC2, it is important to keep it clean from the start to avoid damages. First use a vacuum cleaner or upright vacuum brush cleaner. Then use one of the recommended machines (p 13) to remove building and construction dust and white fibers. Repeat if necessary.



Do not clean the floor before the glue used during the installation of 2TEC2 is completely dry.

3.2 Daily maintenance

2TEC2 needs to be regularly vacuumed like any other carpet. Preferably use a vacuum cleaner with a vertically rotating brush that loosens the dirt and removes it at the same time.

Make sure to use the correct type of brushes to prevent damaging the yarn of the woven top layer.

Daily maintenance can remove up to 80% of the dirt.



The frequency of cleaning depends on the level of use and soiling.

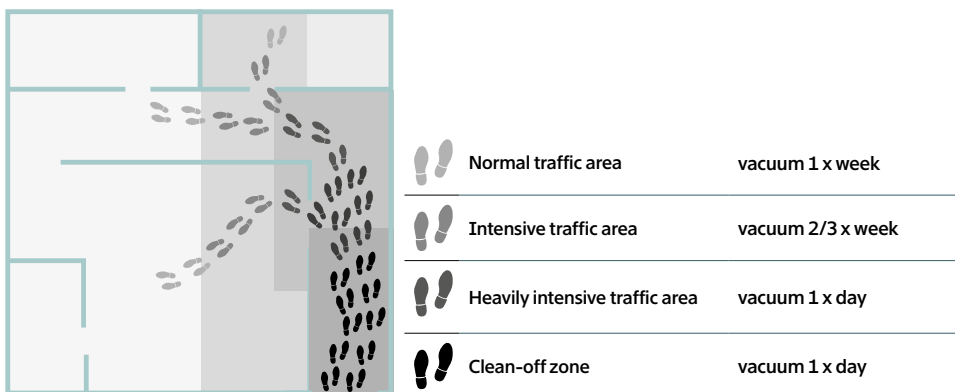

3.3 Periodic maintenance

The goal of periodic maintenance is to preserve a consistent appearance. Vacuum cleaning alone is insufficient in the long run. Depending on the level of traffic, 2TEC2 may need a deep clean (with water). This is usually done at least once a year. The choice of equipment depends on the size of the area to be maintained:

» Medium & large surfaces > 50m² / 500ft²

Maintaining your floor with a cleaning machine equals thorough deep cleaning in a short amount of time with little labour. These machines also ensure low water consumption. There are several appropriate cleaning techniques for deep cleaning 2TEC2. Only use these recommended methods mentioned in chapter 5.

- » Do not use cleaning machines with horizontally rotating pads or brushes
- » Avoid abrasive scouring pads or paper
- » Avoid temperatures above 100° C for more than 5 minutes

Use a professional cleaning machine that:

- » Loosens the dirt
- » Cleans with water and/or steam
- » Removes dirty water

Check p 13 for approved machines and cleaning techniques.

» Small surfaces < 50m² / 500ft²

2TEC2 can also get a manual deep clean. Scrub the surface with a humid, medium hard brush to loosen the dirt. Rinse with plenty of water and extract the dirty water with an adapted wet vacuum cleaner. The water can also be absorbed manually with a dry cloth or mop.

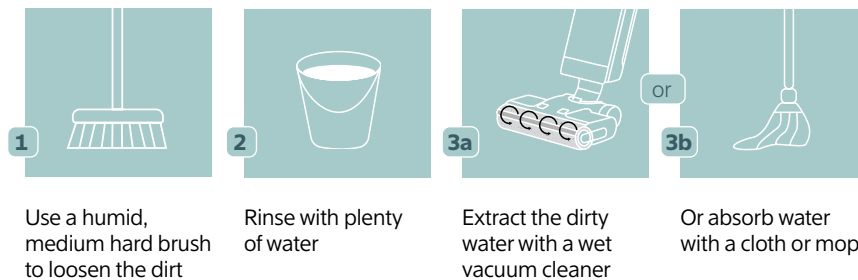

Dirty cleaning water that is not extracted will evaporate and cause stains or aureoles.



If stains or spots are still visible on the floor after deep cleaning, check our recommendations for spot cleaning on the next page.

4. Spot cleaning

Stains should be dealt with immediately, this to avoid discolouration of the top layer or hardening of the dirt. In many cases, stains can simply be removed with just water. When using detergent, always rinse thoroughly and repeatedly to make sure all of it is washed away. Detergent that is left behind will become sticky after drying and attract dirt.

4.1 General spot cleaning

Moisten the spot by spraying it with water. Dissolve the stain with a medium hard brush and be sure to reach the deeper levels of the flooring. Rinse with water and absorb the water with a cloth. Repeat if necessary.

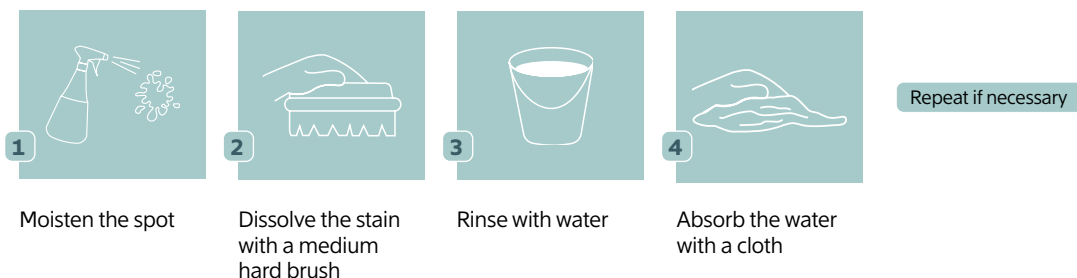

4.2 Stubborn stains

- Use pH-neutral diluted detergent or diluted bleach in case of persistent stains.
- Never use solvents (e.g. acetone or polish) as this may damage the floor permanently.
- Do not use abrasive tools to clean or remove stains.

4.2.1 Stains caused during renovations

Try to plan the installation of 2TEC2 as one of the last steps of a renovation. If 2TEC2 is already installed and the renovation works are still in progress, use protection foil to avoid damage and stains. Do not use self-adhesive protective film, as the glue can get between the yarns of the top layer.



! Oil-based and/or dried paint stains are not removable.

* soapy water: water with just a minimum of soap is usually sufficient.

** approved cleaning chemicals: Orange Power Plus Prowin / HG sticker remover / WD40 universal degreaser / Dasty Degreaser Classic.



Discover our videos

4.2.2 Food and beverages



Hot drinks
Hot water



Cold drinks
Water



Food
Soapy water*



Red fruits
Soapy water*

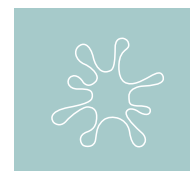

Chewing gum
Remove the gum.
If necessary
apply a product**.
Rub over it with a
microfiber cloth.



Sauces (ketchup)
Soapy water*



Cooking oil & mayo
Hot soapy water*
or cleaning
chemicals***



Red wine
Water



Greasy or strongly coloured food can cause permanent discolouration if not cleaned immediately.

4.2.3 Other common stains



Blood
Water or white spirit

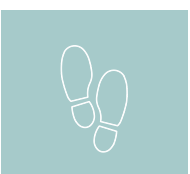

**Marks from shoe
soles (scuffing)**
Degreaser***



Urine
Bleach



Rubber wheels
Degreaser***

* **soapy water:** water with just a minimum of soap is usually sufficient.

** **product:** Progenta Pro Neutral or a gum freezing product.

*** **approved cleaning chemicals:** Orange Power Plus Prowin / WD40 universal degreaser / Dasty Degreaser Classic.



5. Maintenance in healthcare

The healthcare sector requires extra attention to keep 2TEC2 clean and disinfected as this can be crucial for patient safety. An appropriate cleaning protocol is of great importance and can be life saving! Hospital flooring has to be able to withstand heavy use each day while remaining safe and hygienic.

5.1 Expected standards

Easy cleanability: It is easy to eliminate all contaminations on 2TEC2, when applying the correct cleaning technique, as described later in this brochure.

Resistance to daily cleaning: Thanks to 2TEC2's high colour fastness, daily cleaning will not have any influence on its appearance.

Resistance to chemical products: Frequent and repeated use of disinfectants will not have any influence on 2TEC2's appearance.

Contribution to a healthy environment: 2TEC2 has been tested on its contribution to fungal growth and antibacterial activity:

- **Fungal growth according to EN14119-A2:** after contaminating 2TEC2 with 5 different spore suspensions, there is **grade 0 growth activity** after 28 days of incubation time.
- **Antibacterial activity according to ISO20743:** contamination of 2TEC2 with 2 different types of bacteria. After incubation, extraction and counting the growth and activity of the bacteria, the efficacy of **2TEC2's anti-bacterial properties can be concluded as strong.**

5.2 Disinfecting 2TEC2

Keeping germs under control is a key part of staying clear of illnesses or infections. But cleaning alone is not always enough to protect patients.

Cleaning is not the same as disinfecting:

- **Cleaning** a floor means that all dirt and contaminations are being removed. This process does not necessarily kill germs, but it does keep their numbers as low as possible, avoiding the risk of spreading potential infections.
- **Disinfecting** a floor means that all germs and micro-organisms are being killed, thanks to the use of steam or a disinfectant. It is important that the floor is already as clean as possible before starting this process. The more contamination there is during disinfection, the less effective it is.

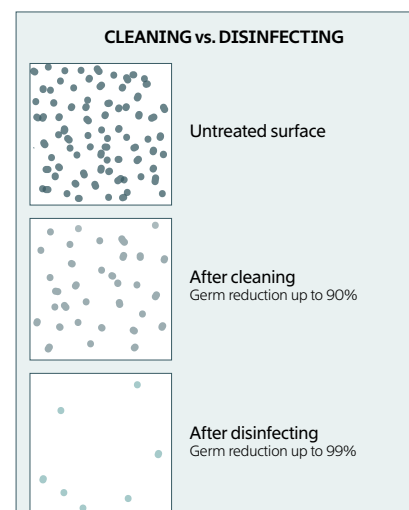

When disinfecting 2TEC2 with steam, germs and micro-organisms are being removed deeply into the woven top layer without using a detergent. When using a steam-cleaning machine it is important to not stay at 1 place for longer than 5 minutes with temperatures higher than 100°C.

Contaminations can also be eliminated with lukewarm water and a pH-neutral detergent, in combination with the correct cleaning technique. Check our recommended cleaning techniques further in this brochure.



The necessary level of cleaning and disinfecting depends on the type of area.

5.3 Types of areas

How frequently a floor in healthcare needs to be cleaned, and the type of procedures, can vary depending on the type of area. 2TEC2 can perfectly be used in low & medium risk areas:

- » **LOW RISK AREAS**, where no patient care takes place
e.g. Entrance, front desk, office areas, hall ways, circulation areas, restaurants, ...
- » **MEDIUM RISK AREAS**, where non-invasive patient care takes place
e.g. Consulting rooms, patient rooms, bathrooms, (sterilized) material storage, waiting areas, ...

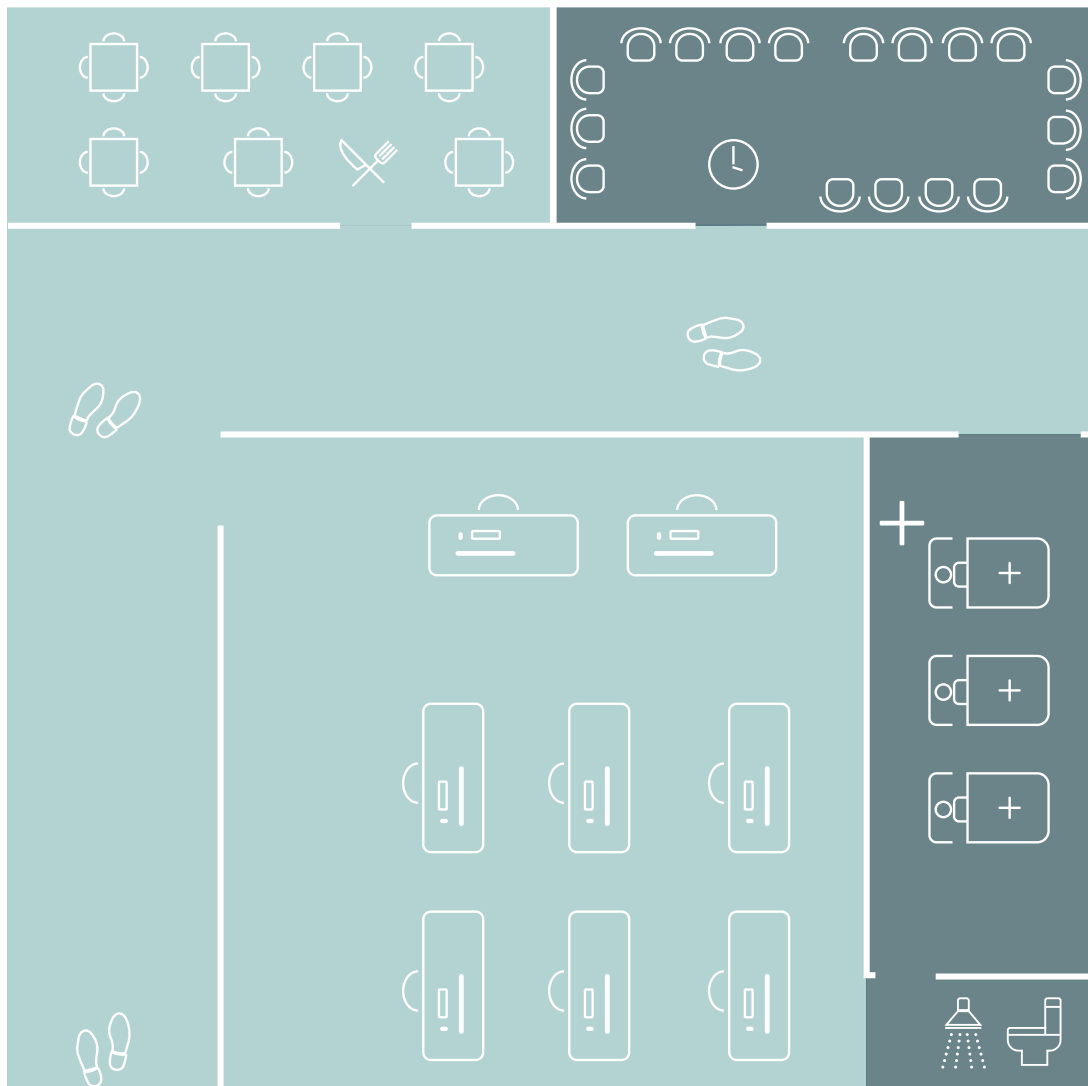

Do not use high pH maintenance products.

Frequent use of high pH maintenance products may damage 2TEC2, this can cause discoloration and degradation of the top layer.

5.4 Chemical resistance & recommended products

<u>PRODUCT</u>	<u>CONCENTRATION</u>	<u>ACCORDING TO</u>	<u>CLASSIFICATION</u>	<u>APPLICATIONS</u>
Chlorine	100 mg/L	ISO 105-E03	Excellent resistance	E.G. Swimming pool water
Bleach	14°		Excellent resistance	E.G. Javel
Ethanol	> 70%		Excellent resistance	E.G. Cleaning gel, hand sanitizer

Constantly under technical improvements

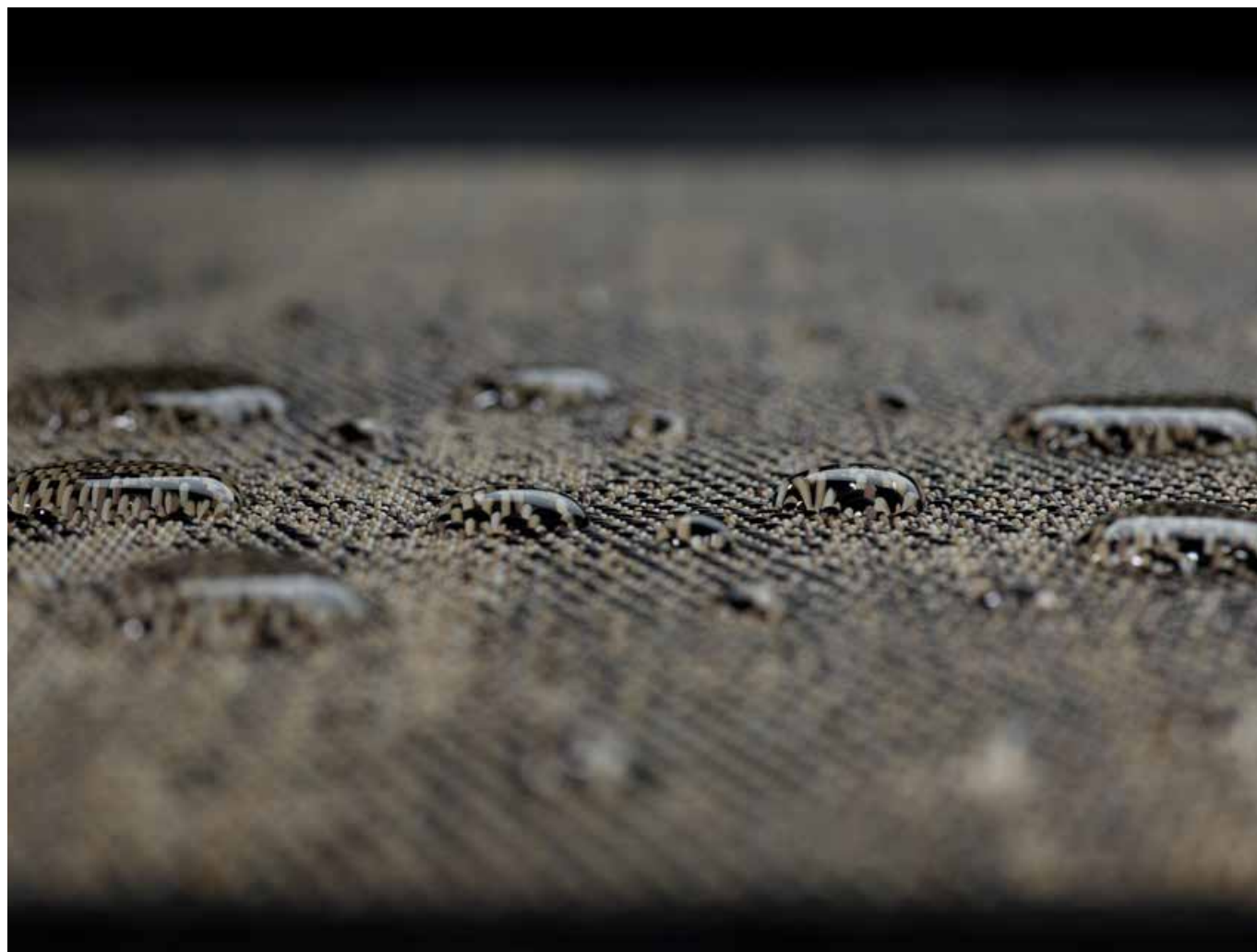

6. Machine recommendations

In our lab, a team of professionals tested various cleaning machine techniques on different types of dirt and stains. We have been working together with various cleaning machine manufacturers to find the best cleaning techniques for keeping 2TEC2 looking like new.

Below an overview of the most effective cleaning methods for keeping 2TEC2 clean.

6.1 Daily maintenance

» Vacuuming

Use a vacuum cleaner with a **vertically rotating brush**. Make sure its suction capacity is strong enough to extract the dust from inbetween the woven top layer.

Sebo Dart 2, supplied by Progenta, is perfect for the daily maintenance of 2TEC2. This vacuum cleaner has a very high suction power, is user-friendly and easy to manoeuvre.

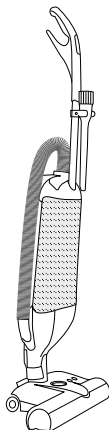

TESTED & APPROVED:

>> **Sebo BS 360/460**

>> **Sebo Dart 2**

- + Easily manoeuvrable
- + Strong suction capacity

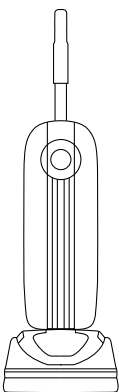
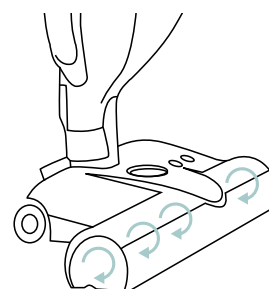

TESTED & APPROVED:

>> **Aspiro Dry Brush**

- + Wireless
- + Soft cover
- + Light weight

6.2 Deep clean - large surfaces

» Injection/extraction

Injection/extraction is a deep cleaning method that treats the entire woven surface reaching the deepest corners. It is important that the injection/extraction machine uses medium hard **vertically rotating brushes**. Make sure to use the correct type of brushes in order to avoid damage. The counter-rotating brushes pick up the dirt and transport it to the collection tank together with the injected water.

Adding detergent to the water tanks is not necessary, for heavily soiled floors a splash of vinegar can be added.



Never use foaming products in combination with an injection/extraction machine.



Brushes that are too hard can cause permanent damage.

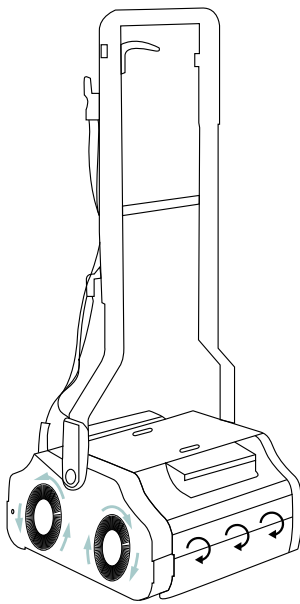

TESTED & APPROVED:

>> **Duplex:** Duplex 280i

Duplex 340 / steam

Duplex 420 / steam

>> **Truvox:** Multiwash PRO 240

Multiwash PRO 340

Multiwash PRO STEAM

+ Low water consumption

+ Easy to use in both large & small spaces thanks to its compact shape

» Encapsulation cleaning method

For the encapsulation method you need a Smart Care Trio machine and a bottle of Crystal Dry cleaning product. This machine sprays a solution, containing the cleaning product and water, on the floor as a mist. This cleaning product exists out of crystals, which are pushed into the toplayer by the 3 cylindrical, rotating brushes of the machine. The crystals encapsulate the dirt and, once dried, they can easily be vacuumed. The concentration of crystals can be adjusted to match the condition of the flooring, allowing to tackle light to heavy soiling. This method uses very little moisture, making it cost-effective, more sustainable, and safer.

Progenta, a cleaning and floor maintenance expert, developed the encapsulation cleaning method: Smart Care Trio.

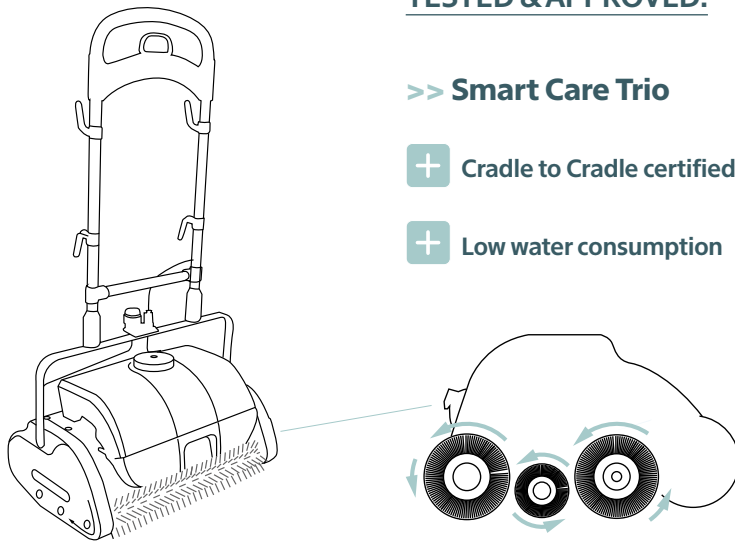

TESTED & APPROVED:

>> Smart Care Trio

- + Cradle to Cradle certified® cleaning method
- + Low water consumption

» Floor Scrubber with high-frequency vibrating head

A **floor scrubber** uses a high-frequency vibrating head (50Hz) and a cleaning pad. Water is applied on the floor just in front of the vibrating head. Thanks to the vibrations, the water goes deep into the woven toplayer, loosening all the dirt particles. Right behind the vibrating head is a vacuum system that sucks up the liquid containing the dirt. The amount of water used for cleaning and the suction power can easily be regulated through the control panel. The cleaning pad most suited for 2TEC2 is the microfibre cleaning pad.

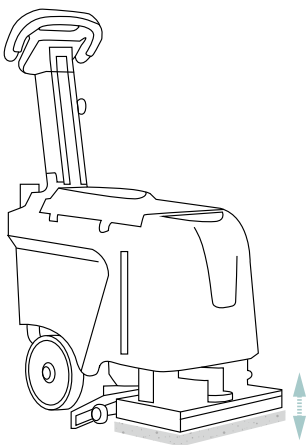

TESTED & APPROVED:

>> KlinMak

- + Ideal for large surfaces
- + Works on battery

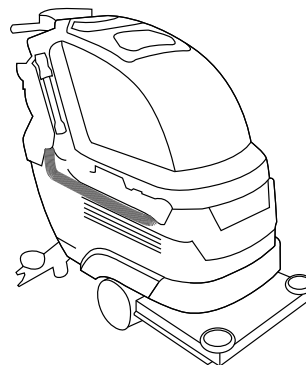

TESTED & APPROVED:

>> COMAC ANTEA 50 BTO

- + Easy controls
- + Anti-bacterial tanks available
- + Control of H₂O & detergent consumption

6.3 Deep clean - small surfaces

» Wet-dry vacuum

More and more wet-dry vacuums of different brands are launched. These types of vacuums can be used for maintaining 2TEC2 only when there is a vertically rotating brush. The brush takes up the dirt, which is directed to the collection tank together with the cleaning water.

The **Dreame H12** does not clean as thoroughly as a professional cleaning machine, but it can serve as a perfect solution for smaller areas. The battery capacity of this vacuum cleaner is +/- 200m².

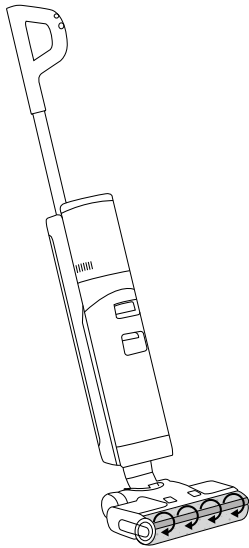

TESTED & APPROVED:

>> Dreame H12

- + Easy to steer
- + Compact
- + Features edge-to-edge cleaning technology, ensuring it reaches right up against the wall

» Encapsulation cleaning method

For the encapsulation method you need a Carpet Roamer and a bottle of Crystal Dry cleaning product. A solution, containing the cleaning product and water, is applied on the floor with the Carpet Roamer. This cleaning product exists out of crystals, which are pushed into the toplayer. The crystals encapsulate the dirt and, once dried, they can easily be vacuumed. The concentration of crystals can be adjusted to match the condition of the flooring, allowing to tackle light to heavy soiling.

The **Carpet Roamer**, supplied by Progenta, does not clean as thorough as the Smart Care Trio, but is a perfect alternative for smaller surfaces.

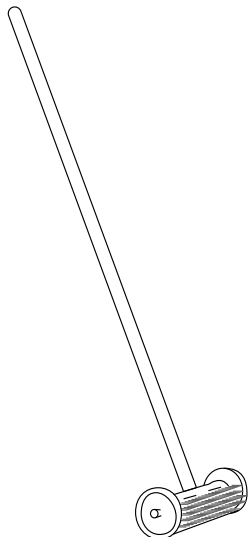

TESTED & APPROVED:

>> Carpet Roamer

- + Very good alternative for a deep clean in small areas
- + Cradle to Cradle certified® cleaning method

7. Professional cleaning contacts

BELGIUM

Cleaning Companies:

Floorcure:
www.floorcure.be

Procobel:
www.procobel.be

Cleaning machine dealers:

Duplex, KlinMak > Dochy Promac:
www.cleanmachine.be

Truvox, Aspiro, Sebo BS, Comac Antea > BOMA:
www.boma.eu

NETHERLANDS

Cleaning companies:

Progenta:
www.progenta.com

Duofort:
www.duofort.nl

Cleaning machine dealers:

Truvox, Aspiro, Sebo BS, Comac Antea > BOMA:
www.boma.eu

FR - BE - LUX - NL - DE - UK

Cleaning companies:

Composil:
www.composil.eu

FR - BE - LUX - NL

Cleaning machine dealers:

Truvox, Aspiro, Sebo BS, Comac Antea > BOMA:
www.boma.eu

EUROPE

Cleaning companies:

Progenta:
www.progenta.com

Cleaning machine dealers:

Smart Care Trio, Carpet Roamer > Progenta:
www.webshop.progenta.com

Sebo > Sebo Dart:
www.sebo.de

US & CANADA

Cleaning machine dealers:

Duplex > Nace Care:
www.nacecare.com

Smart Care Trio > Whittaker:
www.whittakersystem.com

Sebo > Sebo Dart:
www.sebo.de

CONSULTANCY, PLANNING AND TRAINING FOR CLEANING

BOMA:
www.boma.eu

Progenta:
www.progenta.com



Cleaning support & advice



Preparation of a customized maintenance plan



Training & mentoring of cleaning crew

For any feedback or inquiries, please feel free to contact us at any time - www.2tec2.com > contactpage.

8. Do's & don'ts



You may

- Use plenty of water during cleaning. 2TEC2 is waterproof.
- Add vinyl cleaner pH 6 - 8,5 to the water for thorough cleaning.
- Mix vinegar with water (especially for cleaning plaster residues).
- Use diluted ammonia bleach and white spirit.
- Use furniture pads or coasters to prevent scratching, indentations, or traces from heavy furniture. Lift up the furniture to replace it.
- Use chair pads at work stations or offices where castor chairs are used. Use hard, polyamide castors.



Do not use

- Horizontal rotating (cleaning) brushes. This may not remove the dirt.
- Foaming detergent.
- Acetone.
- Abrasive scouring pads.
- Temperatures above 100°C for more than 5 minutes.
- Rubber pads or rubber office chair wheels, as these may cause permanent markings due to discolouration.
- Sharp objects, these can damage 2TEC2 beyond repair. Avoid this by using appropriate protection.

9. Case study



Discover our video



Even when 2TEC2 is thoroughly soiled due to absence of or inadequate cleaning, not all hope is lost! With the help of a professional deep clean machine the floor can be brought back to perfect condition.

Scan the QR code or surf to www.2tec2.com to discover how easy it can be!

10. Frequently asked questions

Can 2TEC2 be mopped?

2TEC2's woven top layer asks for britsles and brushes for a good deep clean. Mopping 2TEC2 will result in a superficial maintenance where the dirt is just moved around. For a good end result it is important that the dirt and the cleaning water are both extracted.

Why not use cleaning products for general maintenance?

When using soap and detergents for general maintenance, chances are that residues are left behind between the yarns of the top layer. Once dried, these residues become sticky and collect dust and dirt, resulting in a dirty floor. A splash of vinegar can be added to the cleaning water to clean heavily soiled floors.

How to keep 2TEC2 looking like new?

Keeping 2TEC2 clean requires 3 basic necessities:

- Use clean water
- Use a brush of medium hardness
- Remove the dirty cleaning water

Can we use a robot vacuum on 2TEC2?

A robot vacuum can be used for the general maintenance of 2TEC2, as long as it has a vertically rotating brush that loosens dust and dirt, and sucks it up after.

Can grease stains cause permanent discolouration?

If grease stains are not dealt with immediately, they can cause permanent discolouration. The visibility of the stain depends on the colour of the floor: the lighter the colour the more visible the stain. Check p 8 for approved products.

What is scuffing? What to do when there are scuffing marks on 2TEC2?

Scuffing is caused when two materials are scraped against each other, leaving a mark. e.g. when a castor or a shoe sole is dragged over 2TEC2. Scuffing can cause permanent damage to the yarn of the top layer. If there is a scuffing mark, and the yarn is not damaged, a degreaser might help to clean the mark. 2TEC2's testing team had good results with Orange Power Prowin Plus. In case of irreversable damage, simply replace the damaged tiles with spare ones.

Can a professional cleaning machine damage 2TEC2?

If the correct cleaning machines are used appropriately, no damage should occur. However, staying in the same spot with rotating brushes for too long, or not using the correct type of brushes (too hard) can damage the yarns of the top layer.

How do I remove chewing gum from my 2TEC2 floor?

This depends on how long the chewing gum has been sticking to the floor. The longer, the more difficult it will be to remove it. There are certain products that can help, like HG chewing gum remover. You can also use a freeze spray on the gum and then scrape it off. Pour lukewarm water over the stain, brush the dirt away, and rinse with water.

What about cleaning machines that use steam?

Cleaning machines that combine wet cleaning with steam can be used for maintaining 2TEC2. However, make sure the warm steam does not stay in the same spot for too long, as this can damage the top layer.

What to do with a partly damaged floor?

In case of rolls, the complete floor needs to be redone. When tiles are installed, it is possible to replace only the damaged tiles. We always advice to keep some spare tiles after the installation of 2TEC2 is done.

Can 2TEC2 be maintained like a wooden floor?

Although our Silva collection may look like a wooden floor, 2TEC2 cannot be compared to one. Do not wax or oil 2TEC2 floors. Follow the cleaning methods as explained in this brochure.

Can 2TEC2 be installed at a fireplace?

2TEC2 is classified Bfl-s1 in terms of fire resistance, the highest possible classification for combustible products. Nevertheless, it is important to be careful around heat sources. PVC can suffer irreversible damage if burned. Watch out for ash from fireplaces, ashtrays, or stoves.

Healthcare facilities need intensive and frequent cleaning with disinfectant. Can 2TEC2 withstand this heavy maintenance?

2TEC2 yarns are mass-dyed and coloured to their core, making them exceptionally colour-fast. Using chlorine, disinfectants or other cleaning agents will not lead to fading.

About our warranty



2TEC2 high-tech woven flooring is easily maintained and designed to remain beautiful for a long time. This makes it the perfect flooring solution for commercial use in hospitality, workspace, healthcare and multi-family projects.

Proper maintenance is crucial for 2TEC2 to meet the expectations in terms of durability, appearance, and hygiene.

- For normal use, and when maintained correctly and regularly, 2TEC2 offers a warranty of 15 years.
- For heavy use, and when maintained correctly and regularly, 2TEC2 offers a warranty of 5 years.
- Failure to respect the maintenance instructions will void the warranty.
- See warranty & sales conditions.
- All commitments made by 2TEC2/Le Tissage are subject to our general conditions.

At the time of publication, all details in this brochure were correct.

2TEC2 reserves the right for updating the information at any time, due to our continuous development and finetuning of the 2TEC2 flooring solutions.

Contact our customer service or sales department for the latest updates.

2tec2[®]
high tech flooring

Headquarters and showroom

Chaussée d'Aelbeke 284
7700 Mouscron - Belgium
+32 56 85 47 47
sales@2tec2.com
www.2tec2.com